

PRODUCT BROCHURE

HERADESIGN[®] CREATIVE

***KNAUF*CEILING**
Solutions





TEMPTED
BY NATURE

ONE HUNDRED PERCENT FANTASY, INSPIRATION AND TEMPTATION

The combination of creativity, aesthetics, individuality, environmental credentials and quality – HERADESIGN® Creative. With this originality, all doors are open to the beauty of nature – these are tempting perspectives!

You know the situation, when an idea slowly develops; it grows and solidifies until the perfect design is created. When your idea becomes a plan and when the plan is finally put into action – these are the moments in life that confirm that the job is not just a profession, but a vocation. Take advantage of the opportunity to implement your most unusual ideas, or even expand on them. Benefit from HERADESIGN® Creative.

// Let yourself be tempted
by new ideas!



PRODUCT PROPERTIES THAT SET US APART

Sound absorption

When using HERADESIGN® Creative shapes / modules, not only the variety of design but also the acoustic well-being of the users of a room can be improved. Due to the very good sound-absorbing properties of HERADESIGN® wood wool tiles, the reverberation time is shortened, the noise level is lowered and speech intelligibility increased.



High quality and sustainable raw materials

HERADESIGN® uses magnesite as the ideal binder for wood fibres. Magnesite protects the fibres and keeps them permanently elastic. For the production process only wood from sustainable forestry is used (PEFC and FSC certified).



Pure inspiration

With the unlimited possibilities that HERADESIGN® Creative offers, you can let your imagination run wild and be inspired for further ideas.



Open and homogenous surface structure

Only with the production technologies and quality standards developed by HERADESIGN® is it possible to produce consistent, open, homogeneous and light appearing surface structures. This unique structure gives the tiles a noble and exclusive character for use in high-quality interior applications.



Regulating humidity and climate

Magnesite is a hygroscopic and is also a building biologically certified material. For this reason, HERADESIGN® acoustic tiles have, in addition to their acoustic and decorative properties, humidity and climate regulating functions.

Dimensional accuracy and tolerances

HERADESIGN®, is the only manufacturer using continuous band forming technology, this enables production with incredible thickness tolerances of only +/- 1 mm.



Product portfolio

As the only manufacturer of wood wool products for visual applications, HERADESIGN® offers a range of decorative closed pore surfaces in addition to the classic visible fibre surfaces..

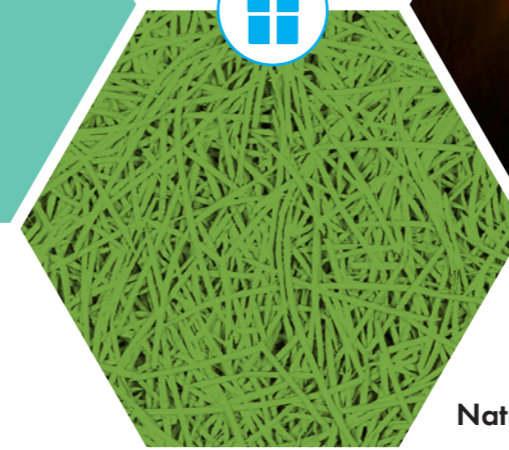

Nature on trend

In addition to the certificate "Building Biology Harmless" (Institute for Building Biology in Rosenheim), HERADESIGN® also focuses on sustainability and resource conservation in terms of product technology and use of raw materials (EPD - AUB environmental declaration according to EN ISO 14025)





HERADESIGN® CREATIVE
FROM THE IDEA TO
REALISATION

NATURAL RAW MATERIALS THE BASIS OF OUR PRODUCTS

Wood, water and magnesite – that is HERADESIGN® Creative

Thanks to the natural main components of HERADESIGN® Creative acoustic tiles – wood, water and magnesite – the tiles are a natural product and therefore perfect for applications in interiors of all kinds. The building biologically absolutely

harmless HERADESIGN® Creative acoustictiles already have a proven lifespan of 80 + years in a building. And if it should come to it: thanks to the natural components, the tiles are 100 % recyclable.

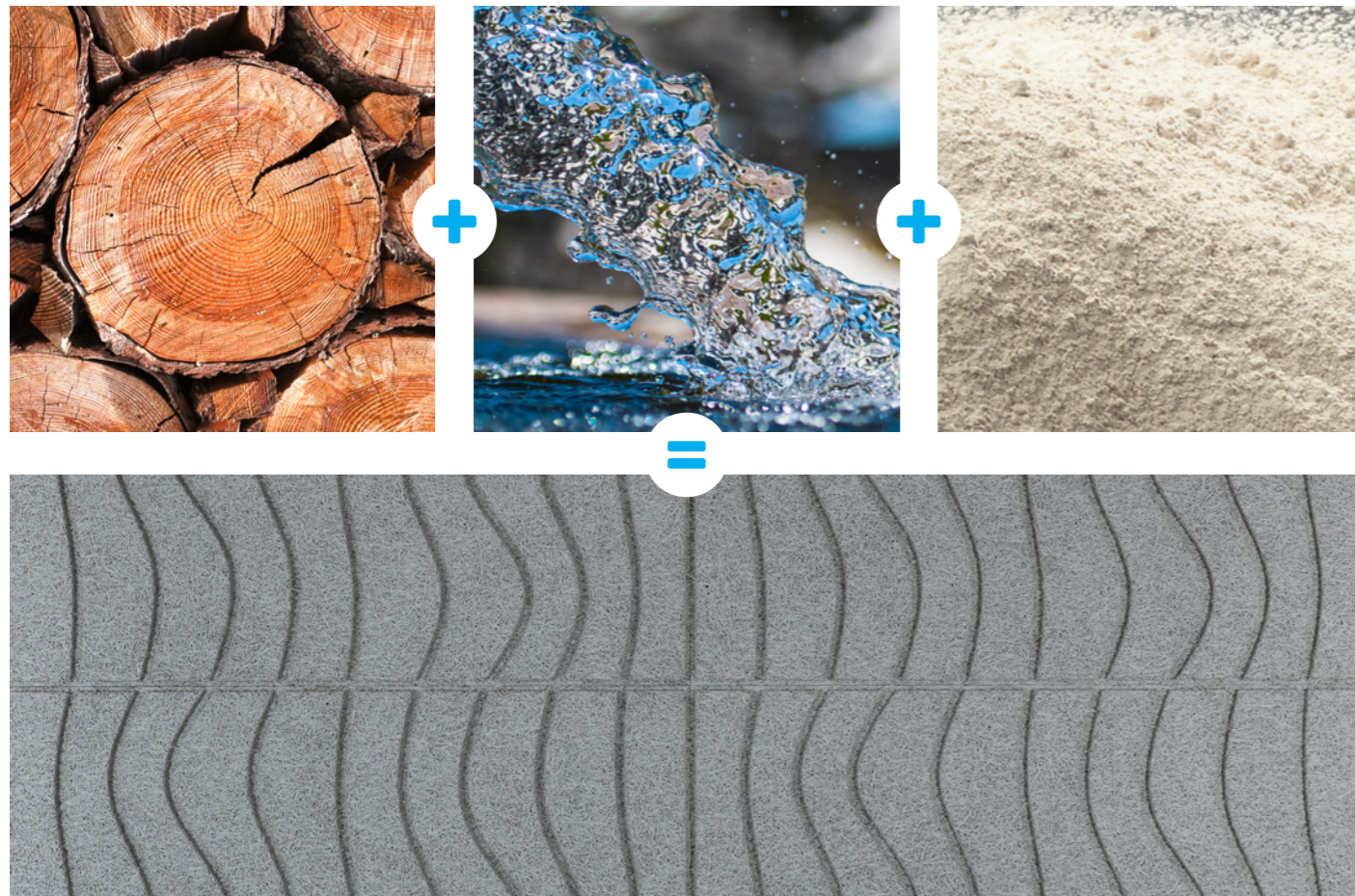

"NATURE MUST BE FELT."

Alexander von Humboldt

Tempted by nature

Aesthetics have always been the most effective form of temptation in nature. With HERADESIGN® Creative, you can be tempted by the unlimited possibilities of using a natural product that expresses the aesthetics of nature through its variety of shapes and colours.

Eco-friendly production

Like nature itself, the material consists of 100 % natural or renewable raw materials, which are completely utilised due to zero-waste production process. The popular HERADESIGN® Creative acoustic tiles are truly environmentally friendly and completely recyclable. For all-encompassing environmental protection, transport routes were analysed, in order to implement environmentally driven transportation methods – so that the beauty of nature is preserved.

HERADESIGN® CREATIVE MODULE

HERADESIGN® Creative Module is a single-layer magnesite-bonded wood wool acoustic panel.

Our product range for you:

Our eight different HERADESIGN® Creative shapes/modules are available as standard in the sizes 300 mm and 600 mm. For the realisation of your more unconventional plans, we are already eagerly at your side with our custom-made products.

- Choose from a selection of eight predefined shapes.
- Available in the surfaces HERADESIGN® Fine, Superfine and Micro.
- Ideal for combining or as stand-alone

Available surfaces:

HERADESIGN® Fine



HERADESIGN® Superfine

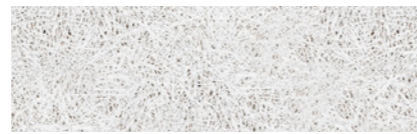

HERADESIGN® Micro

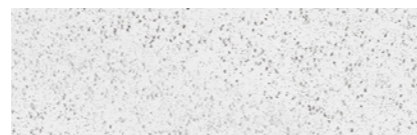

HERADESIGN® Creative Module edge/surface detail

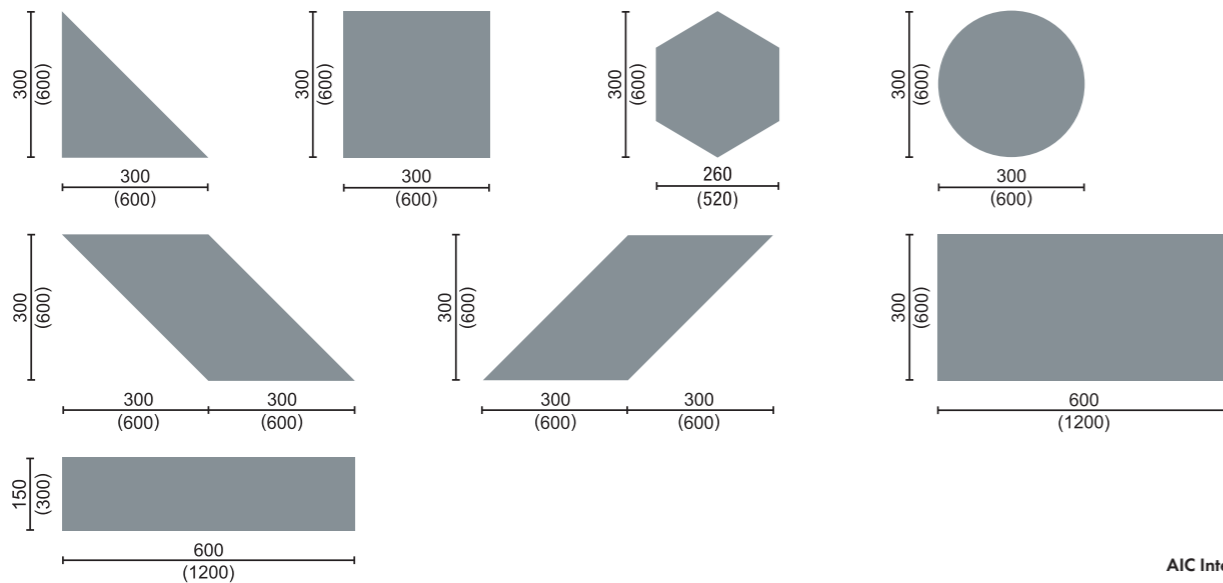
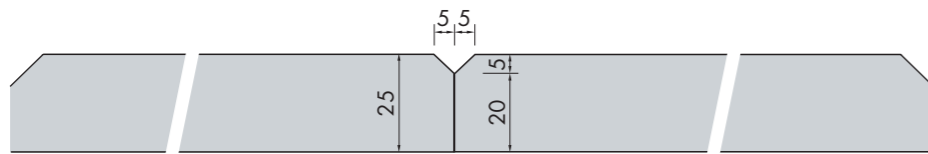

HERADESIGN® CREATIVE LINE

HERADESIGN® Creative Line is a single-layer magnesite-bonded wood wool acoustic panel.

- Flexible and innovative design solution with up to twelve patterns to choose from.
- Defined milled geometric patterns in the panel surface
- For combining or as endless patterns
- Available in HERADESIGN® Fine, Fine A2, Superfine and Superfine A2
- Sound absorption values up to α_w 1.0

Available surfaces:

HERADESIGN® Fine, Fine A2

HERADESIGN® Superfine, Superfine A2

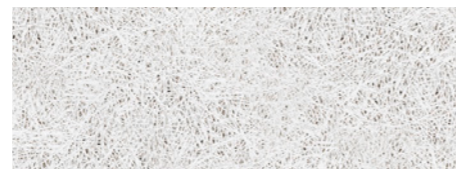

HERADESIGN® Creative Line edge/surface detail

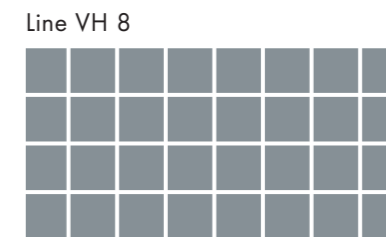
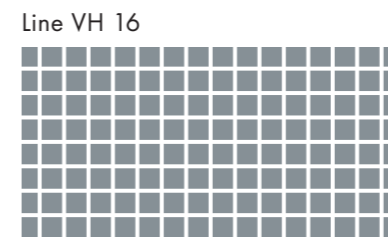
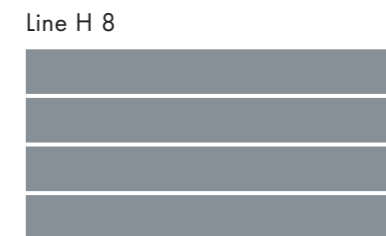
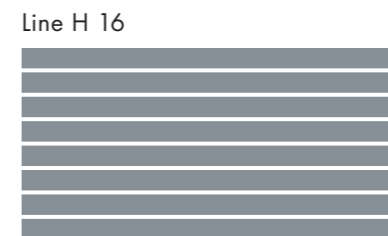
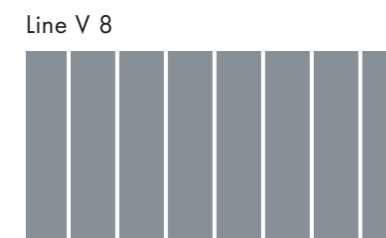
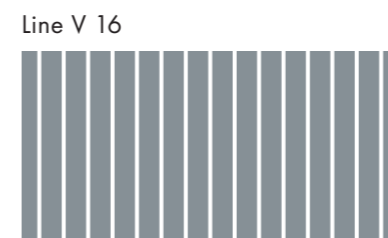
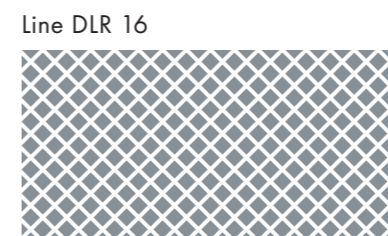
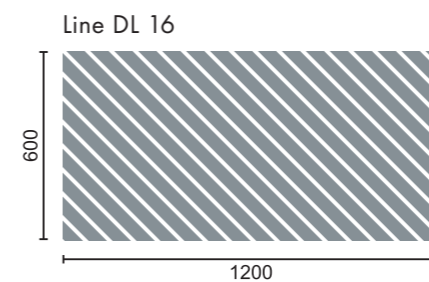
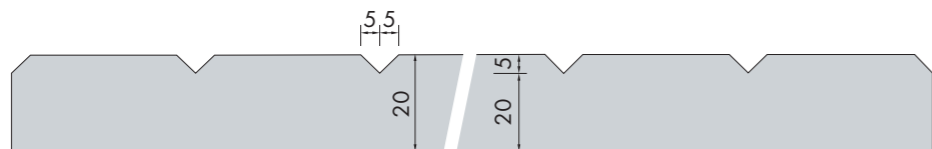

HERADESIGN® CREATIVE EFFECT

HERADESIGN® Creative Effect is a single-layer magnesite-bonded wood wool acoustic ceiling and wall panel.

- Flexible and innovative design solution with up to 8 patterns to choose from.
- Milled grooves of the panel surface in different designs
- Can be used as endless patterns
- Available with HERADESIGN® Superfine, Micro or Plano surfaces
- Excellent sound absorption with HERADESIGN® Superfine.

Groove-H: HERADESIGN®
Superfine, Micro, Plano

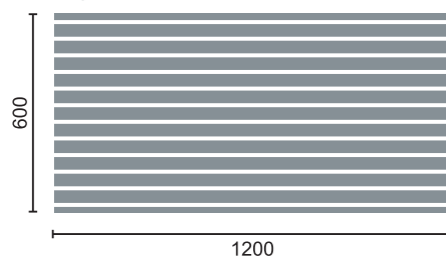

Groove-V: HERADESIGN®
Superfine, Micro, Plano



Zig Zag:
HERADESIGN® Micro, Plano



Mikado: HERADESIGN®
Superfine, Micro, Plano



Wave-V:
HERADESIGN® Micro, Plano



Wave-H:
HERADESIGN® Micro, Plano

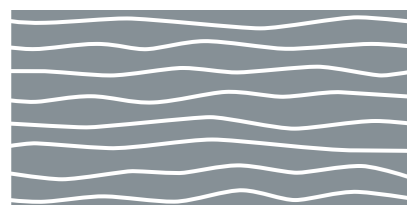

Bubbles:
HERADESIGN® Micro, Plano



Turtle:
HERADESIGN® Micro, Plano

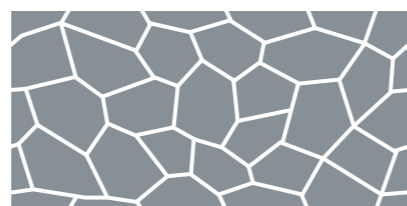

Available surfaces:

HERADESIGN® Superfine

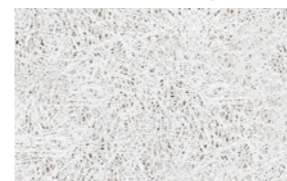

HERADESIGN® Micro



HERADESIGN® Plano



HERADESIGN® Creative Effect edge/surface detail

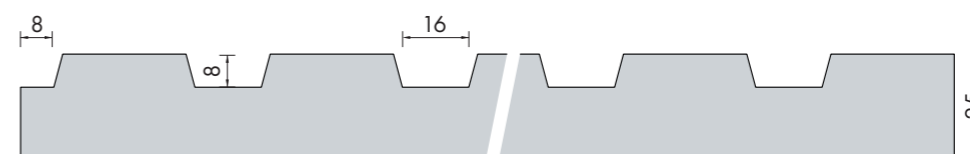

Design possibilities with 3 surfaces:

HERADESIGN® Superfine, HERADESIGN® Micro and HERADESIGN® Plano

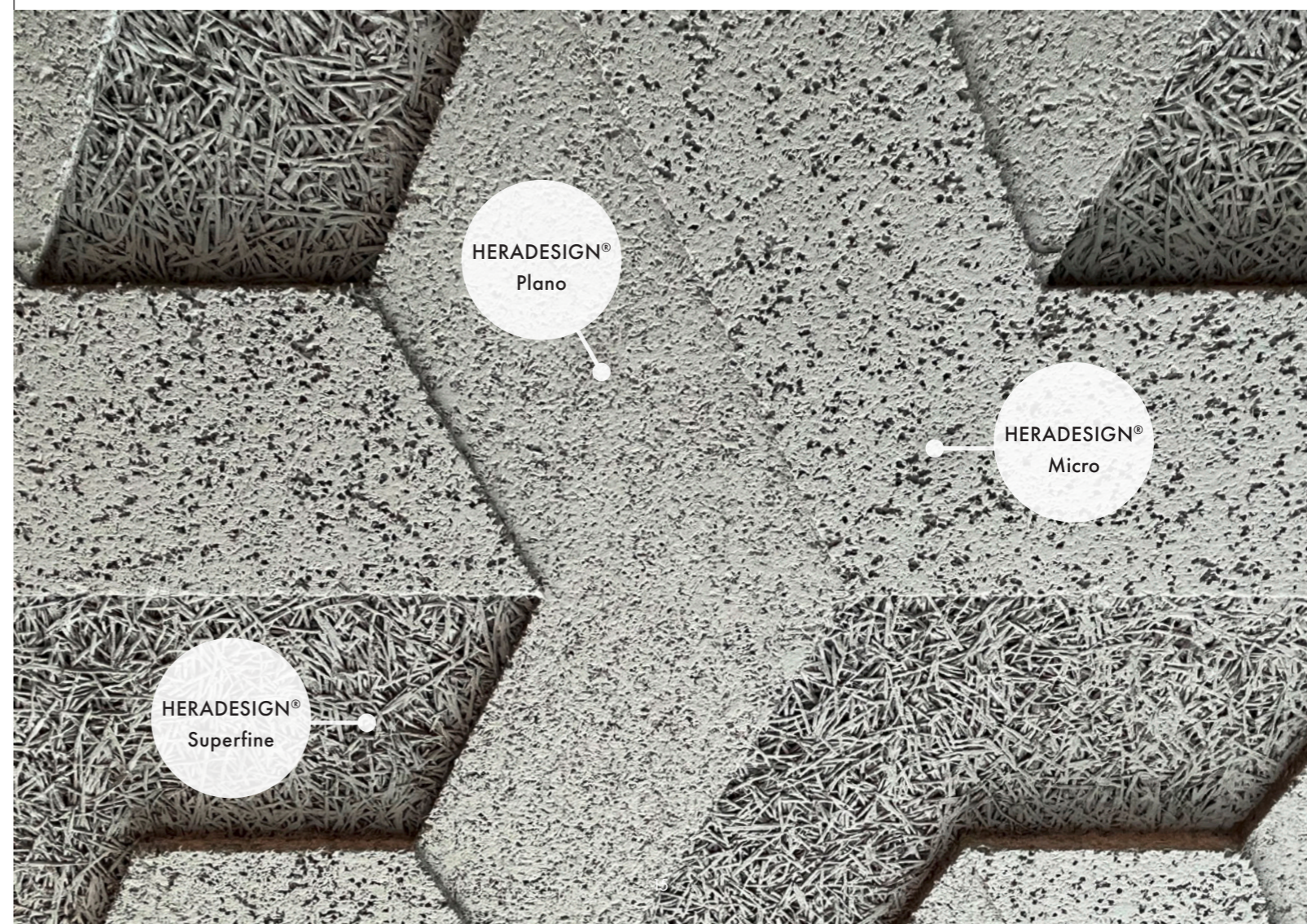

HOW IT'S DONE

8 STEPS TO PERFECTION

BONDING: only possible for HERADESIGN® Creative Modules in grid 300 on the wall up to a height of 3 metres possible

SCREWS: for ceiling mounting in general and wall mounting in module size 600 as well as for HERADESIGN® Creative Effect and HERADESIGN® Creative Line

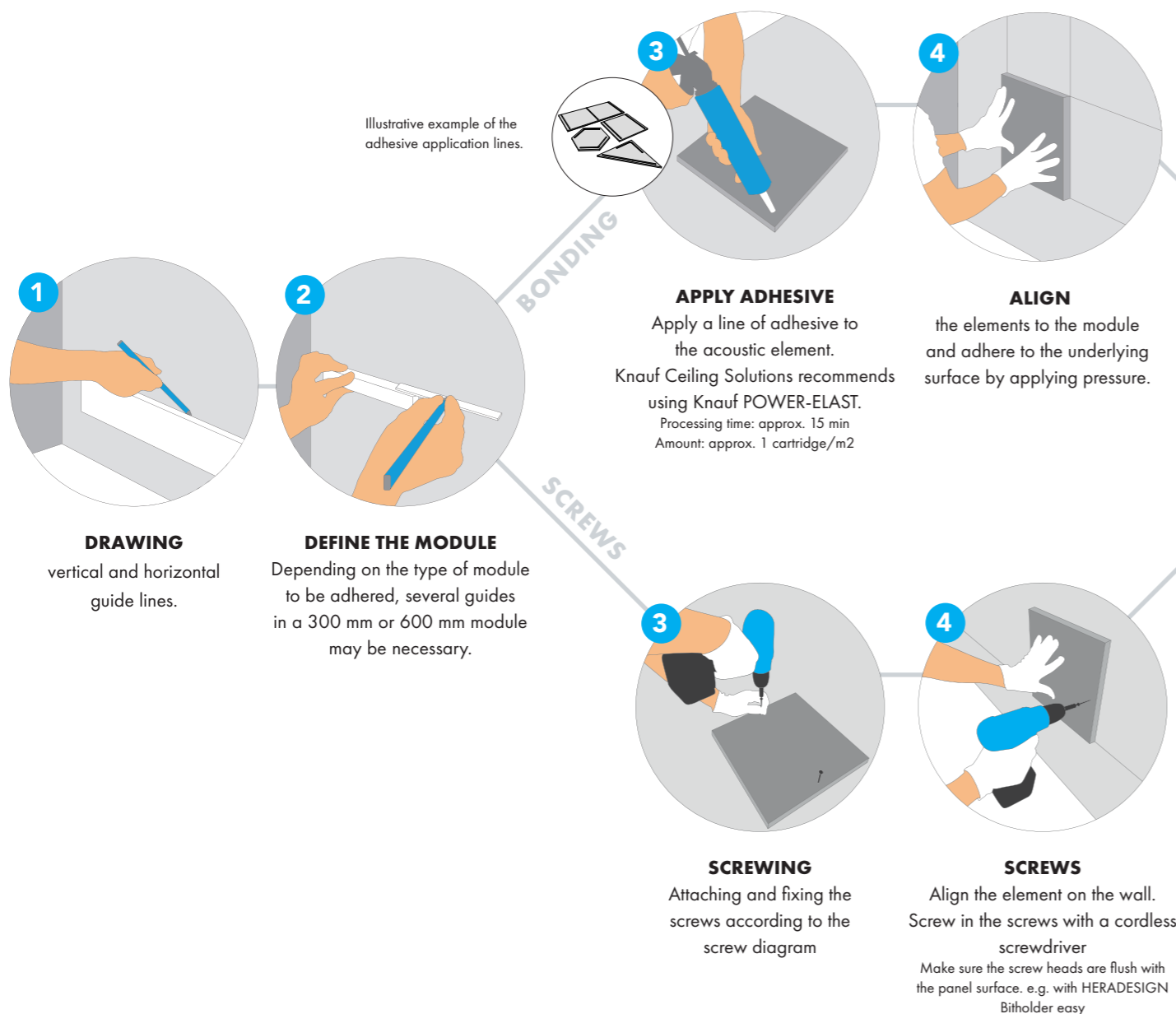

General Guidelines

The adhesive mounting of HERADESIGN® Creative acoustic elements is only possible for HERADESIGN® Creative modules in the 300 grid on the wall up to a height of 3 metres. For installation with HERADESIGN® screws, follow the corresponding procedure. **IMPORTANT:** The underlying surface must be able to take the load, level, dry and dust-free. The general guidelines for the installation of HERADESIGN® wood wool acoustic tiles must be observed.

Quality and care provide the best result

HERADESIGN® Creative shapes/modules are produced with great care, quality controlled and transported to site. Essential factors for a successful and attractive HERADESIGN® Creative application are exact processing and suitable working conditions. Only careful work and high product quality ensure a satisfactory result. Transportation to site, unpacking of the HERADESIGN® Creative products and handling should be carried out with due care. Always work with clean hands and clean tools. We recommend wearing clean gloves.

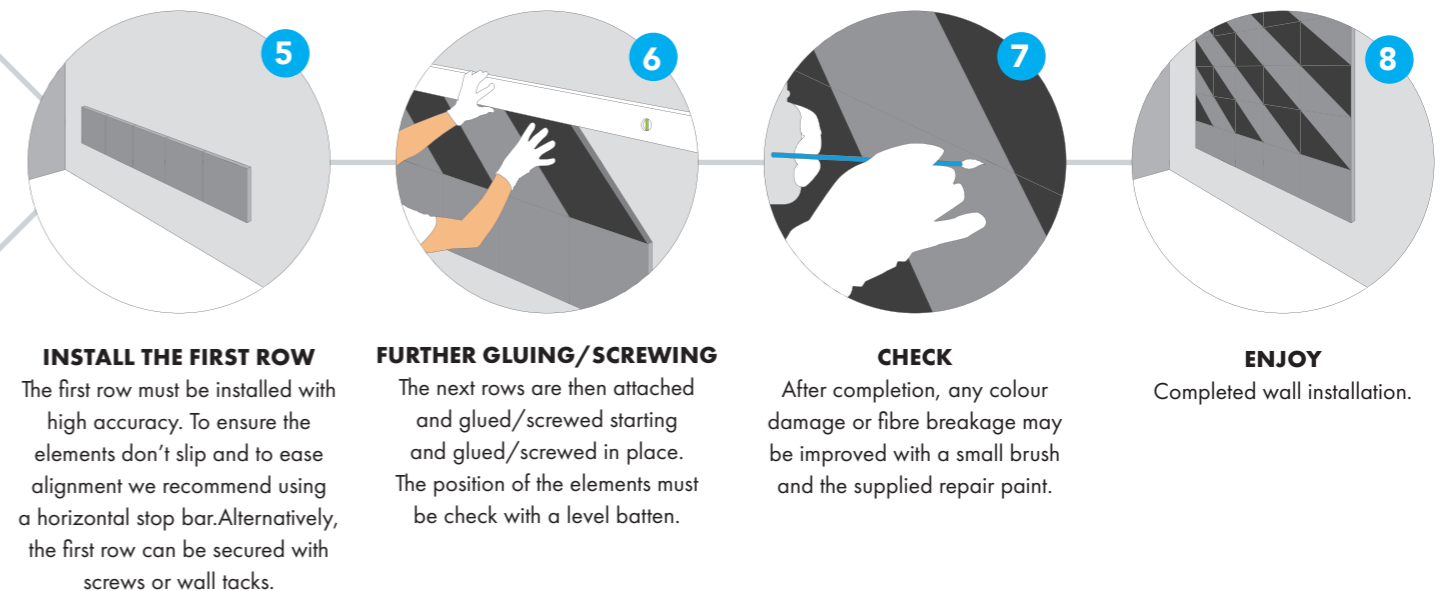



TIMELESS DESIGN

Raiffeisen Digital Hub © Sergiy Kadulin
The Shelf (lower left) © Frederic Schweizer

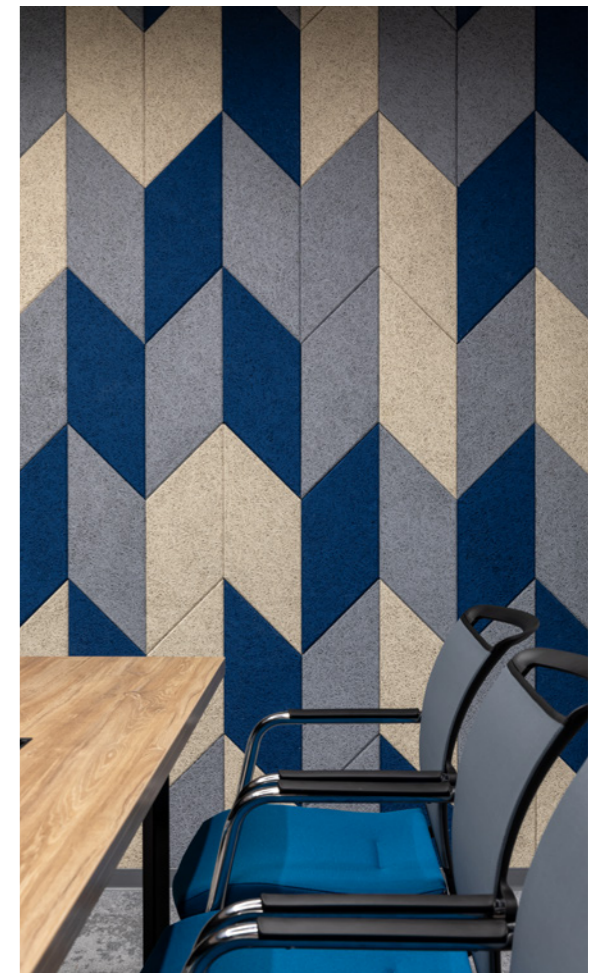

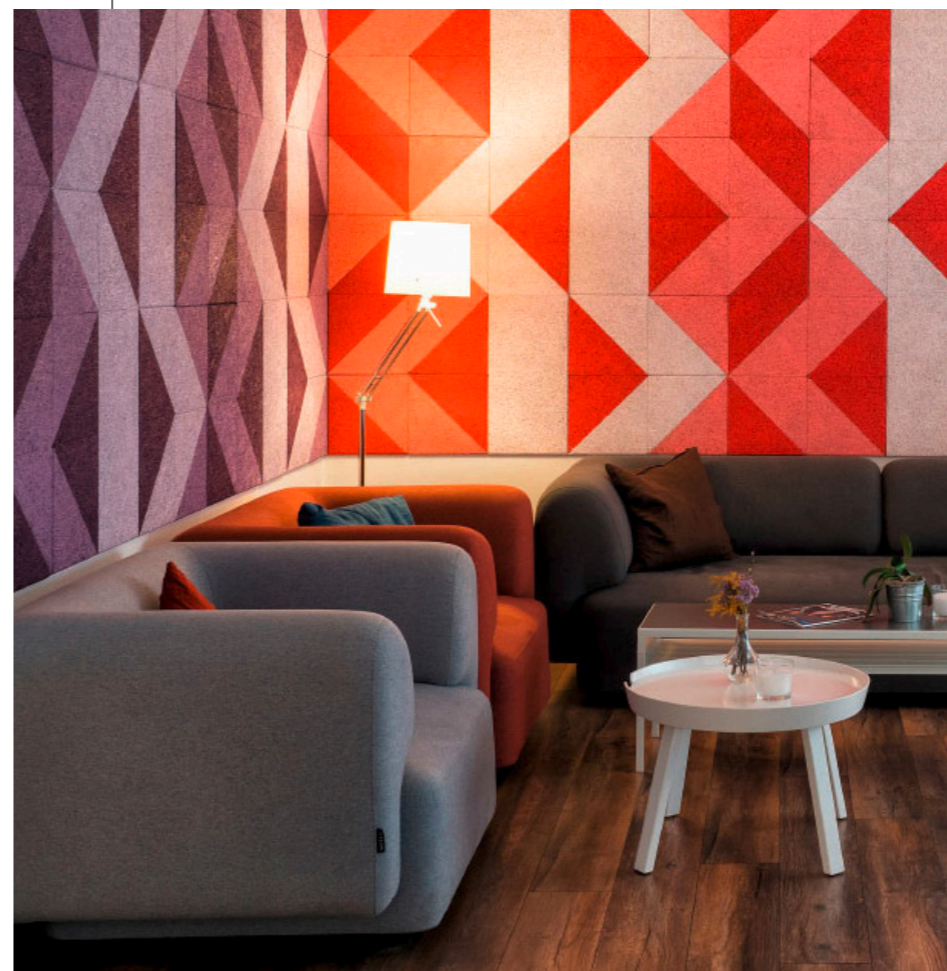

CREATIVITY AND DIVERSITY

AIC International College (left) © Matt Livey

Scuola della musica (right top) © Moreno Maggi

Coworking Space "Share Square" (lower right)



PERFECT HARMONY

Campus Ferndorf (top) © Foto Glanzig
Schwille Architektenpartnerschaft (right) © Stefan Meyer
Paradise Street (lower) © Pro Vision Photography Ltd



YOUR CEILING
OUR SOLUTIONS

Knauf Ceilings Solutions GmbH & Co. KG

Elsenthal 15,
94481 Grafenau, Germany
Phone: +49 8552 422-0
Fax: +49 9323 318-881-856
www.knaufceilingsolutions.com
E-Mail: info.kcs@knauf.com

Registered court: Passau district court,
Registration No.: HRB 1023
VAT No. pursuant to § 27a of the German VAT Act
(Umsatzsteuergesetz): DE131249009
Managing Director:
Karl Wenig